



**This Cargo Barrier is a single position barrier located behind the 2nd row of seats. The Milbolt system featured in this barrier enables easy fitment & removal.**

The Cargo Barrier is designed, manufactured and fitted to decrease the impact hazard in an accident to occupants from cargo carried within the interior cargo space of the vehicle. In the event of an accident, a cargo barrier can reduce injuries caused by cargo intruding into occupant's space.

The installation kit contains sufficient components to fit the Cargo Barrier. A high degree of technical competence is necessary to correctly install this product. We recommend this Cargo Barrier be installed by an Authorised outlet to ensure the barrier installation complies with AS/NZS 4034 Standard.

### WARNING

- Strict compliance with fitting instructions is essential for this safety product to perform as designed. Refer user instructions regarding correct usage of the Cargo Barrier.
- Seat, seat belt or child restraint anchorages must not be used for mounting the Cargo Barrier.
- Where high tensile threaded fasteners are used, the Cargo Barrier must be installed using the size and grade fasteners specified by Millford Industries.
- Do not drill, rivet, adhere or attach objects to the front or rear of the Cargo Barrier.
- When load is positioned against Cargo Barrier, secure the load with a restraint system.
- During a collision moving cargo may damage seat belts or tether straps of a child restraint device, or its anchorage. Load should be carefully positioned so as not to come in contact with these items.
- Do not obstruct seat belts or child restraints, or their operation.
- Long thin items of cargo should be positioned in the vehicle with the long axis across the vehicle to minimize the penetration risk.
- If involved in an accident or accidentally damaged, the Cargo Barrier should be replaced and the anchorage's repaired to as new condition.
- Clean with soap and water only. Do not use solvents or chemicals. Discard Cargo Barrier if it becomes rusted.
- Do not store Cargo Barrier outside in direct sunlight.
- It is extremely dangerous to ride in the cargo area of the vehicle behind the Cargo Barrier. It is recommended that the Cargo Barrier be removed. In a collision people or children riding unrestrained in these areas are more likely to be seriously injured or killed.
- Never leave a child in the vehicle unattended, particularly in the rear cargo area. The cargo area should never be used as a play area for children.
- The Cargo Barrier may deform and significantly intrude into occupant's space in an accident.
- The plaque shall not be removed from the Cargo Barrier.
- Failure to comply with warning notes may prevent the barrier protecting the occupants.

### NOTICE TO FITTERS AND DISTRIBUTORS

Please ensure this notice and the fitting instructions are left in the glove box after installation.

#### TOOLS REQUIRED

- 90° Offset Screwdriver
- Drill
- Masking Tape
- Marker
- Centre Punch
- 16mm,20mm Vinyl Cutters
- Tape Measure
- Steel Rule

#### FITTERS ADVICE

**Note:** To fit the Cargo Barrier the following is essential:

Always drill perpendicular to surface (Unless stated otherwise).

- A positive drill stop should always be used to prevent accidental damage to external panels, fuel lines etc.
- A vinyl cutter assembly should be used for all soft material (ie. Hood lining, floor covering etc). This can be made by grinding the teeth from a hole-saw at an angle of about 45 degrees.
- Care should be taken when applying Tekote Sealer/Rust Preventative to all holes drilled to negate the possibility of skin and eye irritation.
- Check screws in relevant components by hand before installation. Should there be resistance re-tap threads and re-check.

**CARE SHOULD BE TAKEN NOT TO CROSS THREAD THE FASTNERS DURING INSTALLATION OF COMPONENTS TO THE VEHICLE.**

<u>Item No</u>	<u>Component No.</u>	<u>Qty</u>	<u>Component Description</u>
1	752990	1	Mounting Bracket L/H
2	752992	1	Mounting Bracket R/H
3	912830	2	Milbolt 29mm
4	913115	2	Milbolt 59mm
5	753069	2	Mounting Plate
6	906186	2	Marking Pin
7	932030	2	Spring Washer
8	912320	2	5/16 BSW 1/2' Screw
9	904315	2	Neoprene Washer
10	932125	4	3/8" Crinkle Washer
11	905017	2	Adhesive Warning Label
12	906302	1	Cleaning Pad (Not Shown)
13	405800	1	Cargo Barrier (Not Shown)
14	H7604-8H000AU	1	Cargo Blind Fit Kit (Not Shown)



1



2



3



4



5



6



7



8



9



10

**WARNING: DANGER OF CHILD ENTRAPMENT WHEN CARGO BARRIER FITTED**

- Heat stroke or death may occur if trapped in vehicle.
- Tailgate cannot be opened from inside vehicle, causing a risk of entrapment.

905017 Rev B

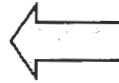
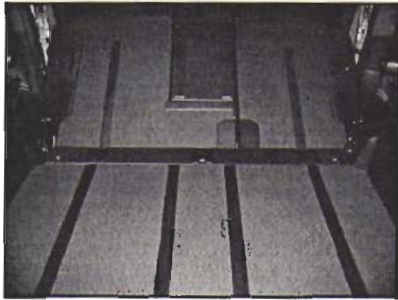

### Bottom Mounts

#### Bottom Mount Installation

1. Fold down the rear seats for easier access to the Child Restraint Anchors (CRA)

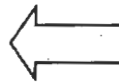

2. Remove rear floor panels to expose the drawer(s).



3. Remove the drawer(s).



4. Remove drawer(s) housing with the 2 clips at rear & 2 turn knobs at front.

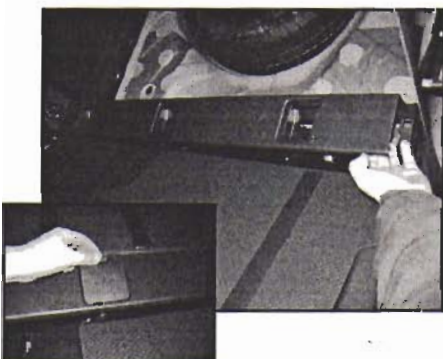

5. Remove CRA covers & then CRA trim. USE CARE WHEN REMOVING CRA TRIM NOT TO DAMAGE ANY FASTENING CLIPS.



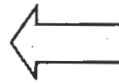

### Bottom Mounts

#### Bottom Mount Installation Passenger's side Shown

6. Locate & remove the two M8 screws under luggage side lower finisher. (Retain screws for re-fitment)



7. Using the M8 screws from step 6 fasten bottom Mounting Bracket (Item 1) to the vehicle. Ensure the orientation of the bracket is correct. (refer insert)  
*M8 SCREW SHOULD BE RE-FASTENED TO 34Nm*

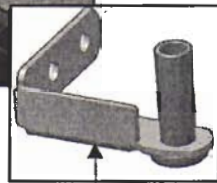

This side to face the rear of the vehicle

8. Repeat steps 6 & 7 on driver's side.

## MARKING & DRILL PROCEDURE FOR CHILD RESTRAINT ANCHOR (CRA) TRIM

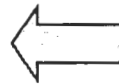
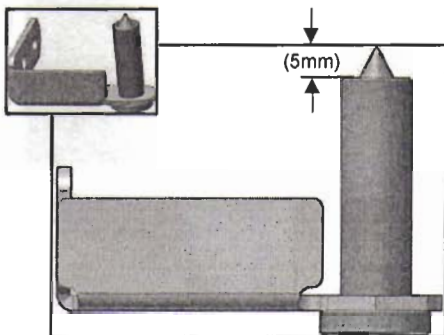

### Marking & Drilling Procedure

1. Screw the Marking Pin (Item 6) into the threaded sleeve of both bottom Mounting Brackets, as shown.



Push firmly here to mark inside of the CRA trim.



2. Re-fit the CRA trim & push firmly down on the ends, so that the pins mark the inside face of the trim.

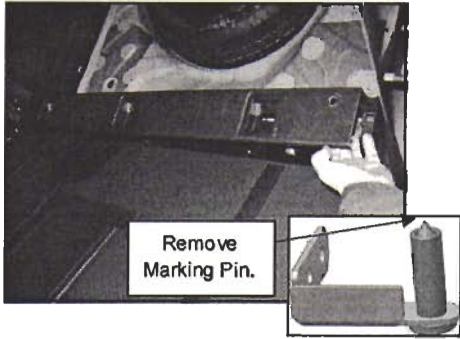

**Marking & Drilling Procedure**

3. Remove CRA trim & Marking Pins (Item 6)  
Retain Marking Pins for top mounts.

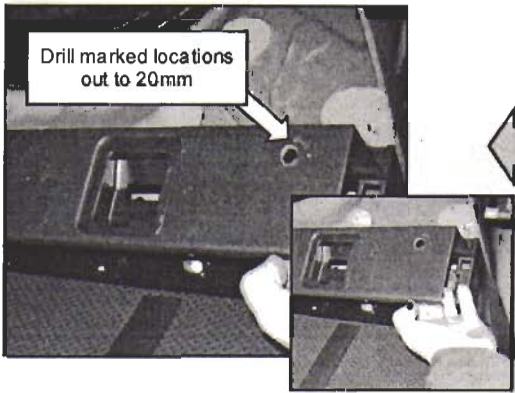

4. Locate where the Marking Pins have marked the inside of the CRA trim & drill the marked locations out to 20mm. (Both sides)



5. Re-fit all removed trim to vehicle  
VACUUM ANY PLASTIC SWarf

### TOP MOUNT MOUNTING LOCATIONS

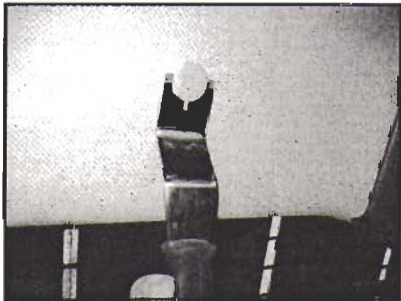

**Top Mount Locations**

1. Locate & remove the 3 trim plugs in soft roof lining near rear tail gate.



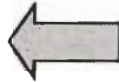
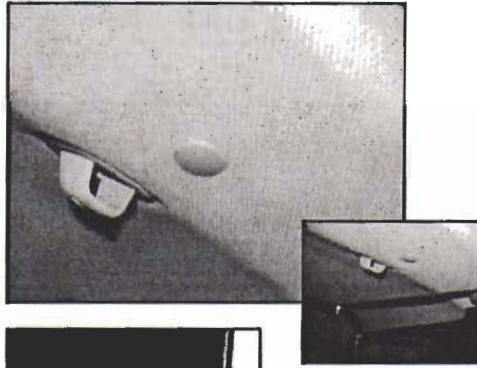

### Top Mount Locations

2. Remove the two coat hooks from soft roof lining near rear tailgate.

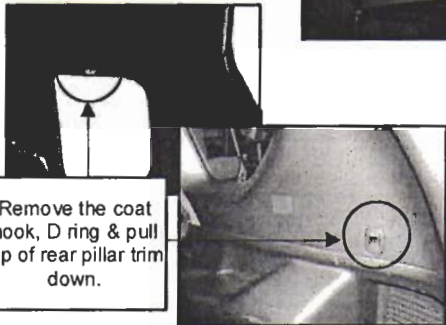

Remove the coat hook, D ring & pull top of rear pillar trim down.



3. For easy access to the top mount locations, remove the coat hook from above the rear quarter window & the D ring above the rear vent. Pry open the top of the rear pillar trim.

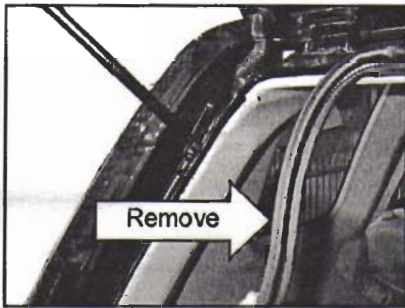

4. Remove rubber tailgate seal from around the rear tailgate.

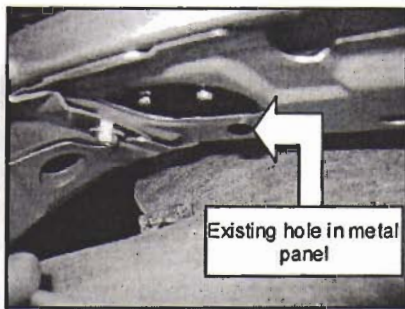

5. Carefully pull down the soft roof lining at the rear of the vehicle to expose the top mounting locations. The existing hole in metal panel is where the 5/16 Screw (Item 8) fastens the Mounting Plate (Item 5) to the vehicle.

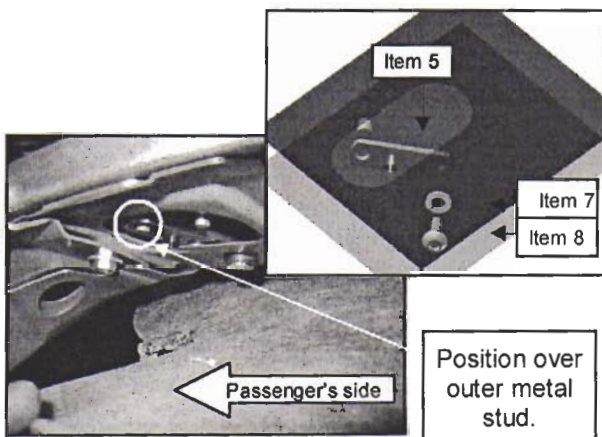

6. Position Mounting Plate (Item 5) into the panel cavity, ensure the 10mm hole is positioned over the outer metal stud & spacer tube is facing towards the soft roof lining as shown. Place Spring Washer (Item 7) over 5/16 Screw (Item 8). Using the 90° Offset Screwdriver fasten the Mounting Plate (Item 5) into position. Repeat on driver's side.

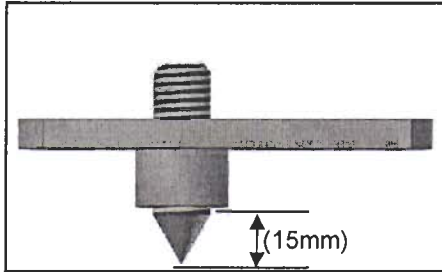

### Top Mount Locations

7. Screw Marking Pin (Item 6) into M10 hole on Mounting Plate (Item 5) as shown.

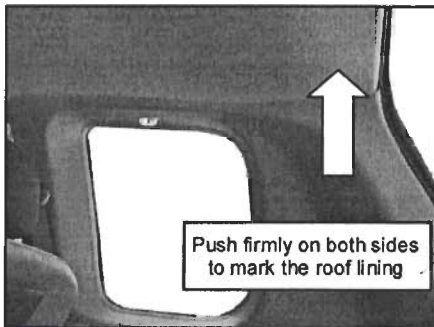

8. To mark the soft roof lining hole locations, push the roof lining firmly against the Marking Pin (Item 6)

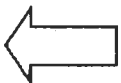
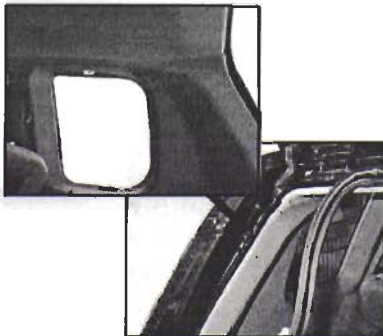

9. Remove the Marking Pins & re-fit all trim, trim plugs, coat hooks, D rings & rubber tailgate seal to the vehicle.

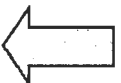
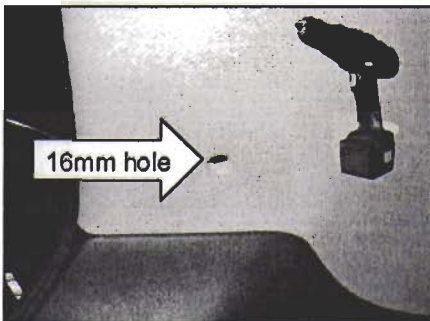

10. Using a 16mm vinyl cutter drill marked location on soft roof lining. Set a drill stop at 5mm to avoid damaging Mounting Plate or outer panels.  
**IT IS RECOMMENDED TO RUN THE DRILL IN REVERSE TO AVOID ANY DAMAGE TO THE TRIM.**



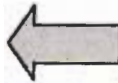
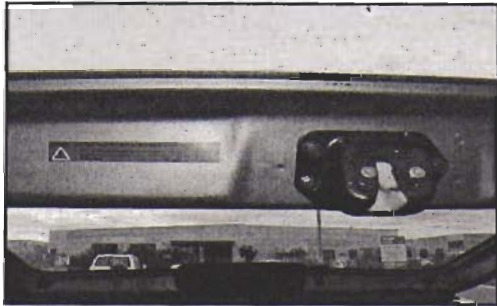

### Installation of Warning Labels

1. Clean the area around the rear tailgate and side of lower dashboard where the Labels are to be affixed with cleaning pad (Item 12), and allow to dry.
2. Affix Labels (Item 11) in locations shown. Light pressure should be applied to adhere Label to surface.

## CARGO BARRIER INSTALLATION

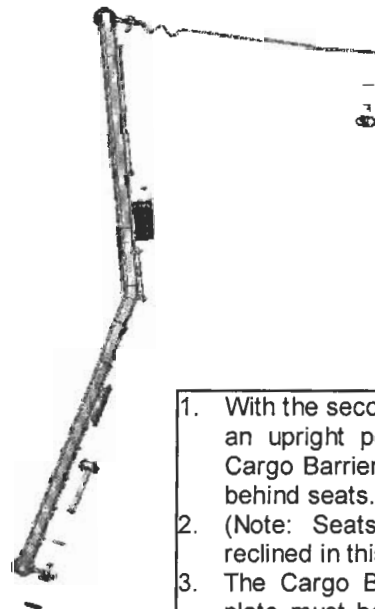
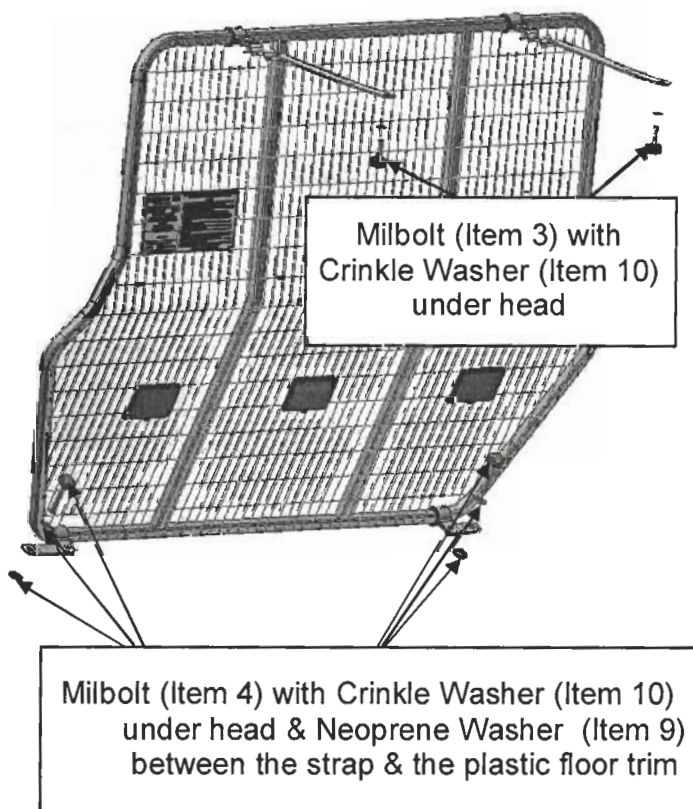

1. With the second row of seats in an upright position, stand the Cargo Barrier (Item 13) directly behind seats.
2. (Note: Seats cannot be fully reclined in this position)
3. The Cargo Barrier compliance plate must be on the left hand side, and facing towards the rear of the vehicle.
4. Attach the top & bottom straps to mounts with 29mm and 59mm Milbolts respectively as shown.

**CHECK THAT ALL BOLTS, NUTS, & SCREWS ARE TIGHT & RE-CHECK PERIODICALLY**